

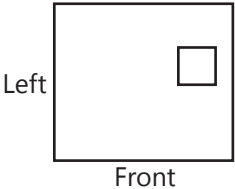

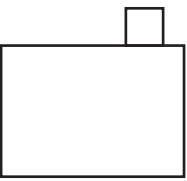
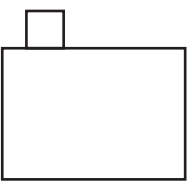
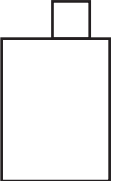
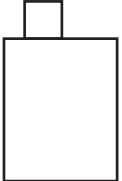

Requirements:

Examples

Check the boxes

All measurements to be in centimetres	185cm 1850mm	<input type="checkbox"/>
Do not add extra for room for fit. Give exact measurements.		<input type="checkbox"/>
Cover drawings to be in blue or black pen.	✓ or ✗	<input type="checkbox"/>
Measurements and indicative lines to be marked in red.	—	<input type="checkbox"/>
Please select the three faces you will draw:*		
<p>a. </p> <p>b. </p> <p>c. </p> <p>d. </p> <p>e. </p>	<p>a. Top <input type="checkbox"/></p> <p>b. Front <input type="checkbox"/></p> <p>c. Back <input type="checkbox"/></p> <p>d. Right side <input type="checkbox"/></p> <p>e. Left side <input type="checkbox"/></p>	
*Drawings do not have to be to scale.		
Select each extra you will add to your cover. Use the pictograms to add them to your diagrams.*		
<p>a. </p> <p>b. </p> <p>c. </p> <p>d. </p> <p>e. </p>	<p>a. Cutout <input type="checkbox"/></p> <p>b. Eyelets <input type="checkbox"/></p> <p>c. Elastic <input type="checkbox"/></p> <p>d. Velcro <input type="checkbox"/></p> <p>e. Zips <input type="checkbox"/></p>	
*Ensure that you give accurate placement and length measurements. See base of page.		

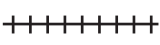
If you have any questions please do not hesitate to call us, email us or check out examples online.

How to measure FACES correctly:

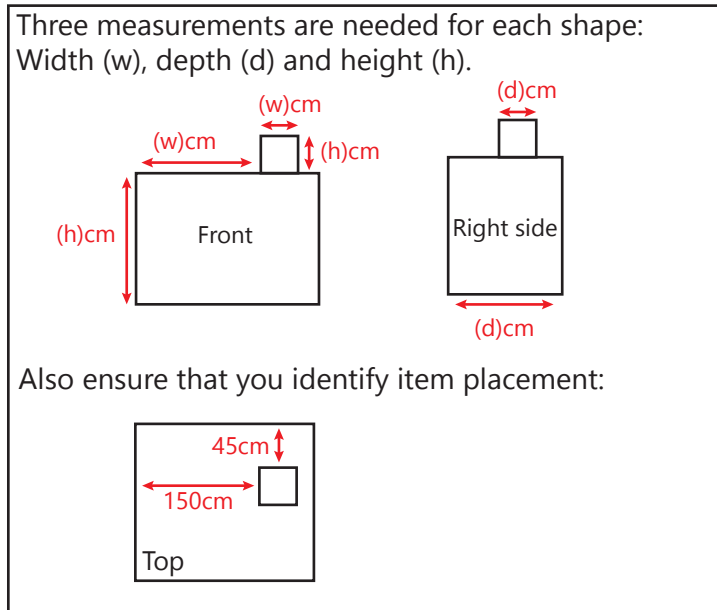

How to specify EXTRAS correctly:

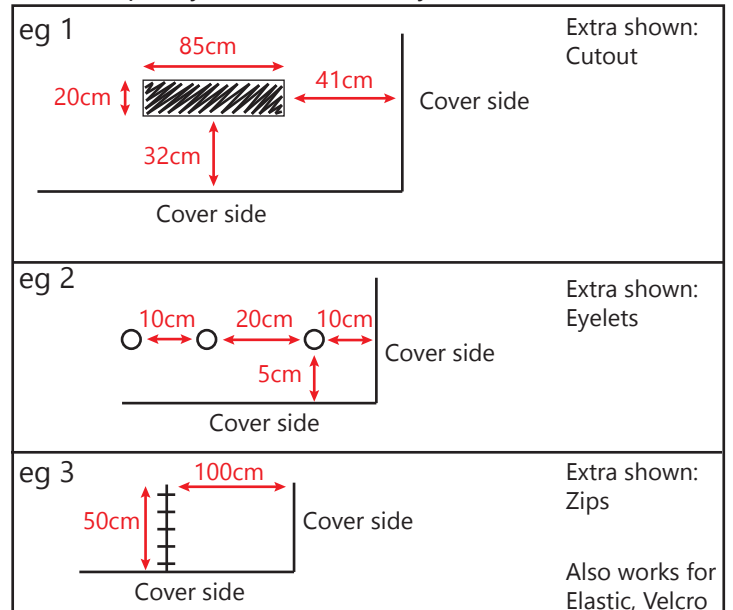

Custom Quote Form

 03 5945 5388

 03 5940 0771

 WWW.COVERITMFG.COM.AU

 2 EMBREY COURT, PAKENHAM , VIC